



## 100V/15A N-Channel Junction Power MOSFET

### Features

- Fast Switching
- 100% Avalanche test

BVDSS	100	V
ID	15	A
RDSON@VGS=10V	70	mΩ
RDSON@VGS=4.5V	84	mΩ

### Applications

- Power factor correction (PFC)
- Switched mode power supplies(SMPS)
- Uninterruptible Power Supply (UPS)

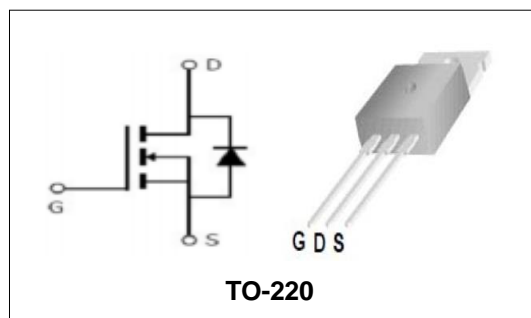

### Order Information

Product	Package	Marking	Tube	Carton
PTP15N10	TO-220	PTP15N10	50PCS	5000PCS

### Absolute Maximum Ratings

Symbol	Parameter	Rating	Unit	
<b>Common Ratings (TC=25°C Unless Otherwise Noted)</b>				
$V_{(BR)DSS}$	Drain-Source Breakdown Voltage	100	V	
$V_{GS}$	Gate-Source Voltage	±20	V	
$T_J$	Maximum Junction Temperature	150	°C	
$T_{STG}$	Storage Temperature Range	-55 to 150	°C	
$I_S$	Diode Continuous Forward Current	TC =25°C	15	A
<b>Mounted on Large Heat Sink</b>				
$E_{AS}$	Single Pulse Avalanche Energy (Note1)	9	mJ	
$I_{DM}$	Pulse Drain Current Tested (Silicon Limit) (Note2)	TC =25°C	40	A
$I_D$	Continuous Drain current	TC =25°C	15	A
$P_D$	Maximum Power Dissipation	TC =25°C	30	W
$R_{θJC}$	Thermal Resistance Junction-to-Case (Note3)	5	°C/W	
$R_{θJA}$	Thermal Resistance Junction-to-Ambient (Note3)	60	°C/W	

**100V/15A N-Channel Junction Power MOSFET**

Symbol	Parameter	Condition	Min.	Typ.	Max.	Unit
<b>Static Electrical Characteristics @ T<sub>J</sub> = 25°C (unless otherwise stated)</b>						
V <sub>(BR)DSS</sub>	Drain- Source Breakdown Voltage	VGS=0V ID=250μA	100	--	--	V
I <sub>DSS</sub>	Zero Gate Voltage Drain current	VDS=100V,VGS=0V	--	--	1	μA
I <sub>GSS</sub>	Gate-Body Leakage Current	VGS=±20V,VDS=0V	--	--	±100	nA
V <sub>GS(TH)</sub>	Gate Threshold Voltage	VDS=VGS,ID=250μA	1	2	3	V
R <sub>DS(ON)</sub>	Drain-Source On-State Resistance (Note4)	VGS=10V, ID=10A	--	70	100	mΩ
		VGS=4.5V, ID=8A	--	84	110	
<b>Dynamic Electrical Characteristics @ T<sub>J</sub> = 25°C (unless otherwise stated) (Note5)</b>						
C <sub>iss</sub>	Input Capacitance	VDS=30V, VGS=0V, F=1MHz	--	525	--	pF
C <sub>oss</sub>	Output Capacitance		--	41	--	pF
C <sub>rss</sub>	Reverse Transfer Capacitance		--	36	--	pF
Q <sub>g</sub>	Total Gate Charge	VDS=50V, ID=3A, VGS=10V	--	15.6	--	nC
Q <sub>gs</sub>	Gate-Source Charge		--	3.2	--	nC
Q <sub>gd</sub>	Gate-Drain Charge		--	4.4	--	nC
<b>Switching Characteristics (Note5)</b>						
t <sub>d(on)</sub>	Turn-on Delay Time	VDD=50V, ID=1A, VGS=4.5V RG=6.8Ω	--	8	--	nS
t <sub>r</sub>	Turn-on Rise Time		--	4.5	--	nS
t <sub>d(off)</sub>	Turn-off Delay Time		--	26	--	nS
t <sub>f</sub>	Turn-off Fall Time		--	3.8	--	nS
<b>Source- Drain Diode Characteristics @ T<sub>J</sub> = 25°C (unless otherwise stated)</b>						
V <sub>SD</sub>	Forward on voltage	IS=10A,VGS=0V	--	0.89	1.2	V
t <sub>rr</sub>	Reverse Recovery Time	IS=10V,VGS=0V, dI/dt=100A/us	--	26	--	nS
Q <sub>rr</sub>	Reverse Recovery Charge		--	115	--	nC

Note:

- Limited by T<sub>Jmax</sub>, starting T<sub>J</sub> = 25° C, R<sub>G</sub> = 25Ω, V<sub>D</sub> =50V, V<sub>GS</sub> =10V. Part not recommended for use above this value.
- Repetitive Rating: Pulse width limited by maximum junction temperature.
- Surface Mounted on FR4 Board, t ≤ 10 sec.
- Pulse Test: pulse width ≤ 300 us, duty cycle ≤ 2%.
- Guaranteed by design, not subject to production testing.



100V/15A N-Channel Junction Power MOSFET

Typical Characteristics

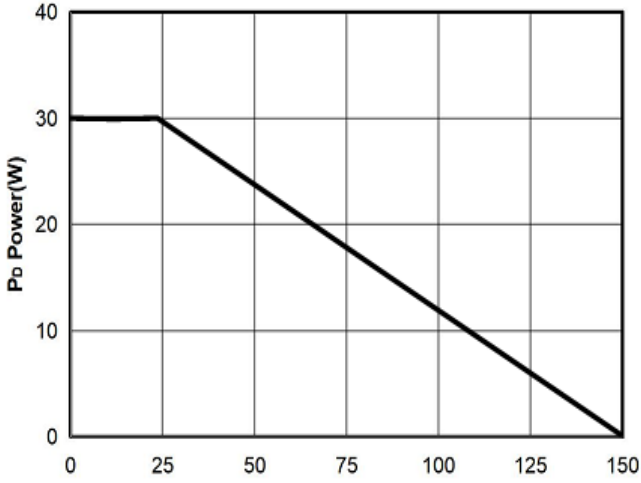

Figure1: Tj Junction Temperature (°C)

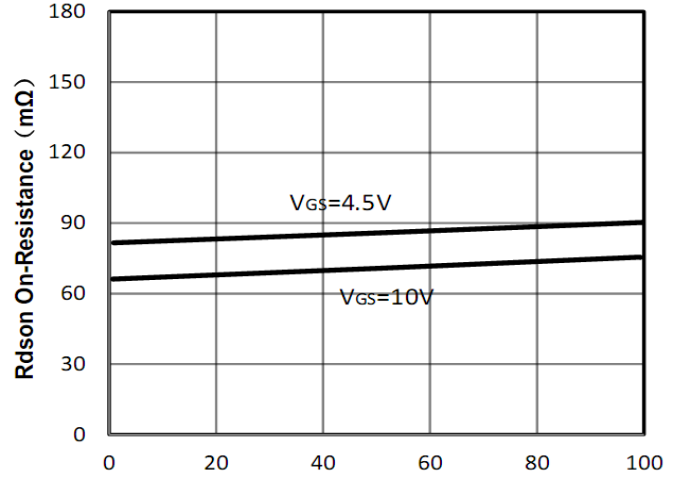

Figure2: Id Drain Current (A)

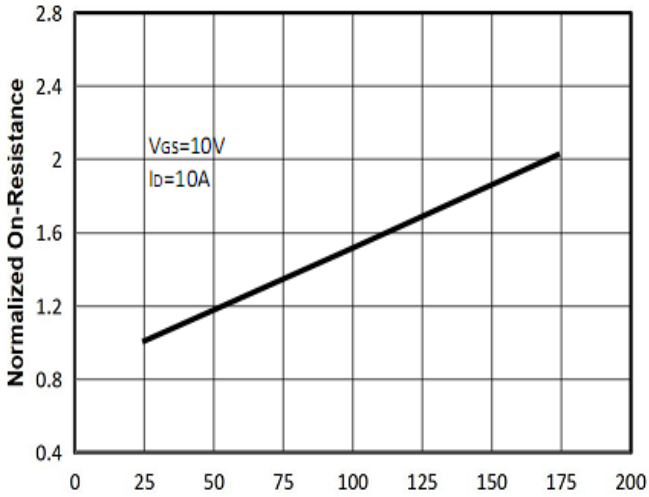

Figure3: Tj Junction Temperature (°C)

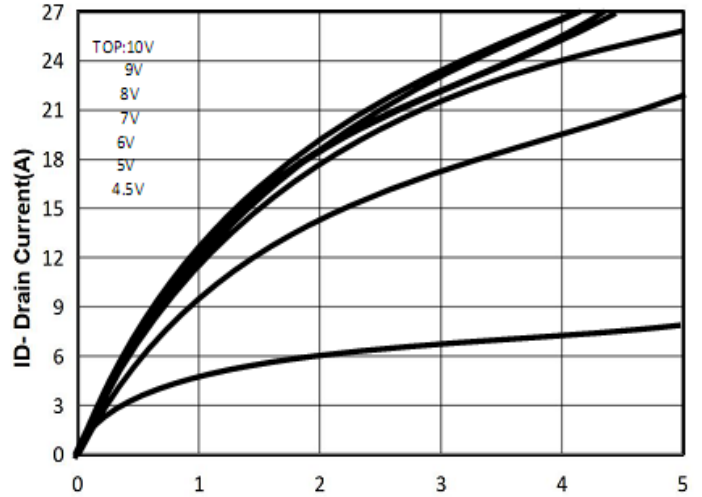

Figure4: Vds Drain-Source Voltage (V)

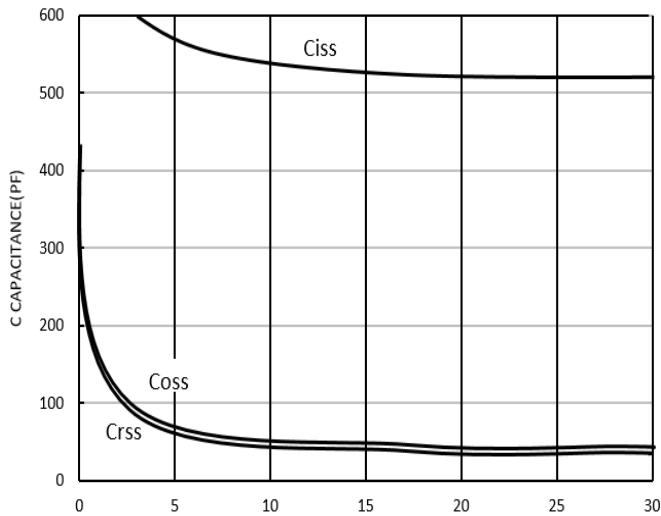

Figure5: Vds Drain-Source Voltage (V)

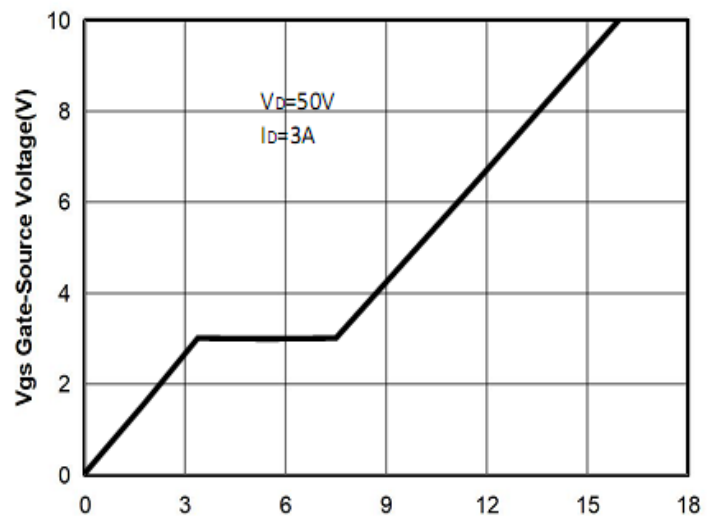

Figure6: Qg Gate Charge (nC)



100V/15A N-Channel Junction Power MOSFET

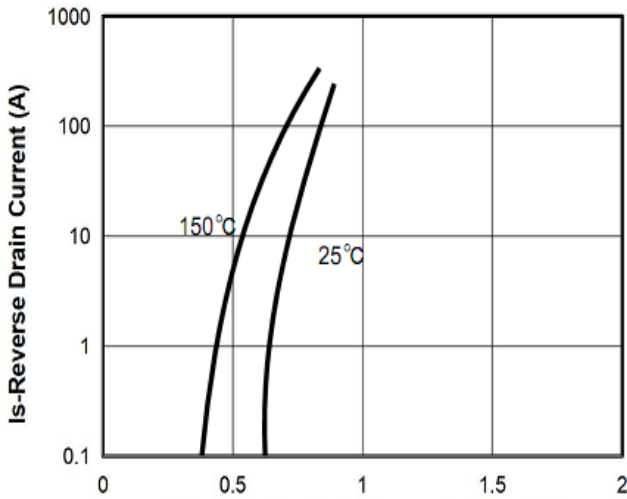

Figure7: Vsd Source-Drain Voltage (V)

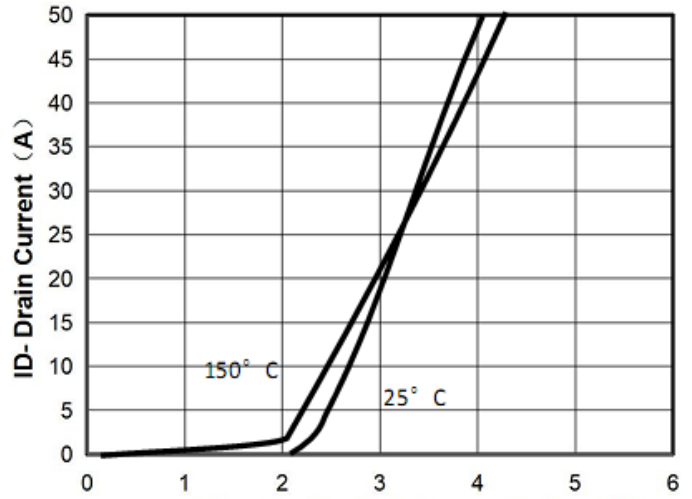

Figure8: Vgs Gate-Source Voltage (V)

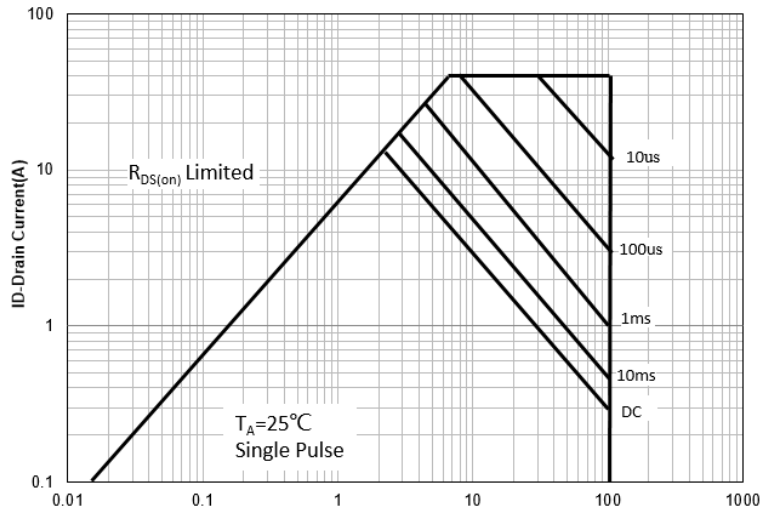

Figure9: VDS Drain-Source Voltage (V)

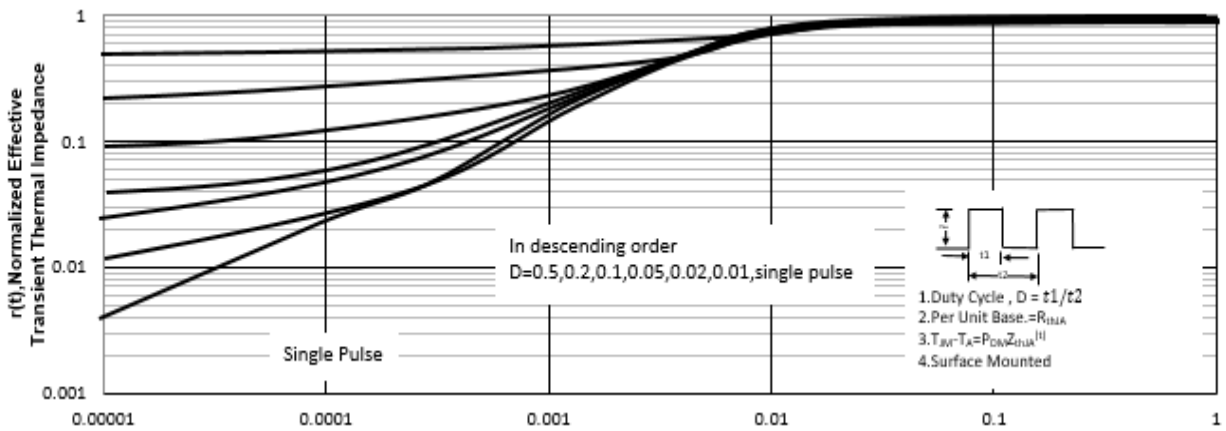

Figure10: Square Wave Pulse Duration (sec)

## 100V/15A N-Channel Junction Power MOSFET

### Test Circuit and Waveform:

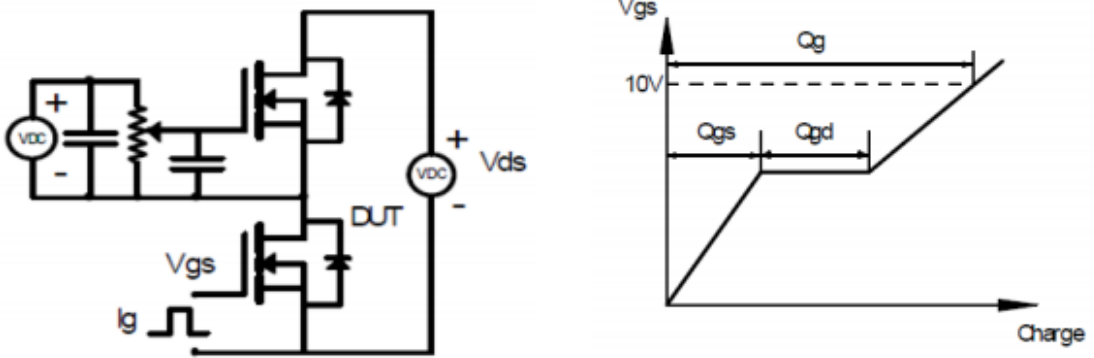

Figure A Gate Charge Test Circuit & Waveforms

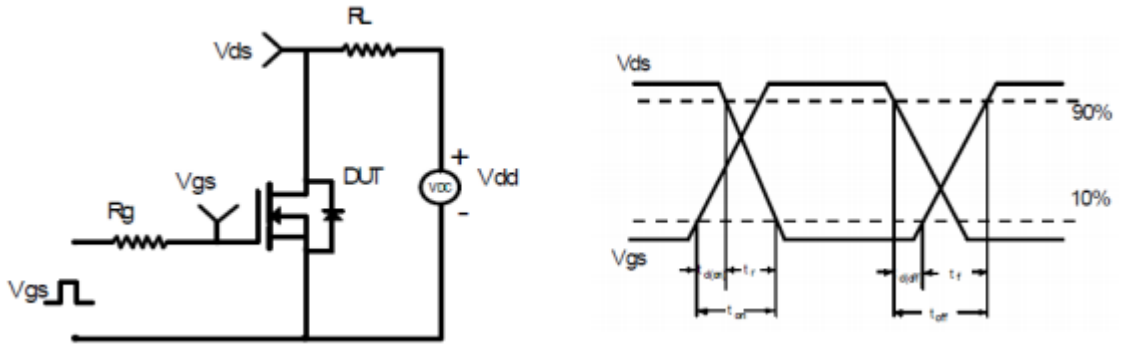

Figure B Switching Test Circuit & Waveforms

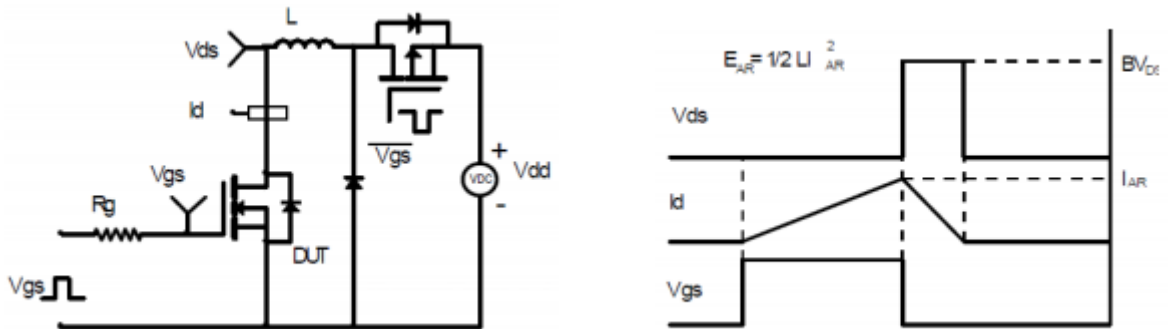
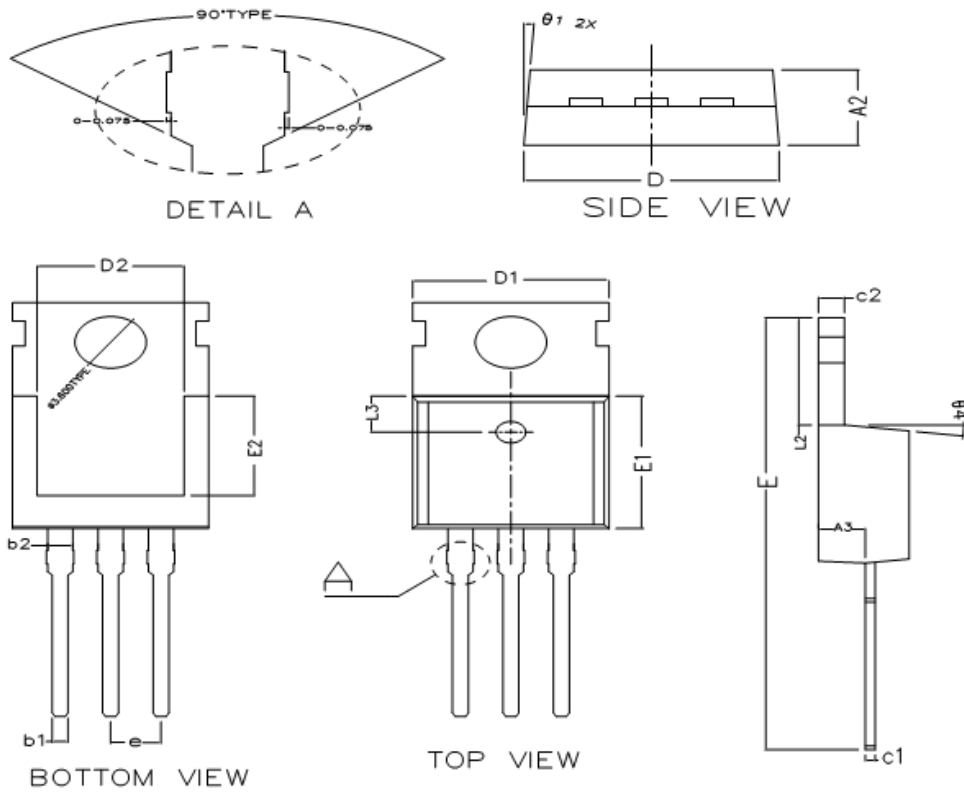

Figure C Unclamped Inductive Switching Circuit & Waveforms



100V/15A N-Channel Junction Power MOSFET

TO-220 Package Outline Dimensions (Units: mm)



COMMON DIMENSIONS (UNITS OF MEASURE IS mm)			
	MIN	NORMAL	MAX
A2	4.470	4.570	4.670
A3	2.300	2.350	2.400
b1	0.750	0.800	0.850
b2	1.27 TYPE		
c1	0.450	0.500	0.550
c2	1.250	1.300	1.380
D	9.900	10.000	10.100
D1	10.000TYPE		
D2	8.000TYPE		
E	28.660	28.860	29.060
E1	9.000	9.100	9.200
E2	7.000TYPE		
e	2.540TYPE		
L2	6.350	6.500	6.650
L3	2.50TYPE		
θ1	3° TYPE		
θ2	3° TYPE		
θ3	7° TYPE		
θ4	7° TYPE		