



## 100V/65A N-Channel Advanced Power MOSFET

### Features

- Fast switching
- Low RDS(on) & FOM
- Low Gate Charge

### Applications

- High Frequency Switching
- Synchronous Rectification

BVDSS	100	V
ID	65	A
RDSON@VGS=10V	7.8	mΩ
RDSON@VGS=4.5V	10.2	mΩ

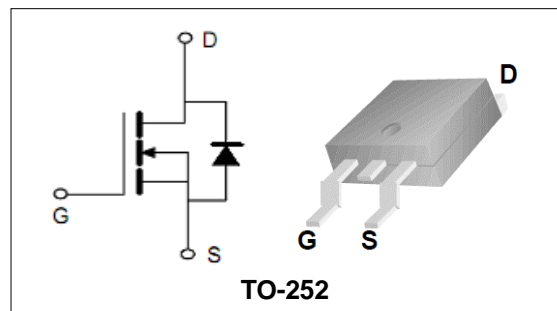

### Order Information

Product	Package	Marking	Reel Size	Reel	Carton
PGD10N100	TO-252	PGD10N100	13inch	2500PCS	50000PCS

### Absolute Maximum Ratings

Symbol	Parameter	Rating	Unit
<b>Common Ratings (TC=25°C Unless Otherwise Noted)</b>			
$V_{(BR)DSS}$	Drain-Source Breakdown Voltage	100	V
$V_{GS}$	Gate-Source Voltage	±20	V
$T_J$	Maximum Junction Temperature	150	°C
$T_{STG}$	Storage Temperature Range	-55 to 150	°C
$I_S$	Diode Continuous Forward Current	TC =25°C 65	A
<b>Mounted on Large Heat Sink</b>			
$E_{AS}$	Single Pulse Avalanche Energy (Note1)	102	mJ
$I_{DM}$	Pulse Drain Current Tested (Silicon Limit) (Note2)	TC =25°C 240	A
$I_D$	Continuous Drain current	TC =25°C 65	A
$P_D$	Maximum Power Dissipation	TC =25°C 90	W
$R_{θjc}$	Thermal Resistance Junction-to-Case (Note3)	1.39	°C/W

**100V/65A N-Channel Advanced Power MOSFET**

Symbol	Parameter	Condition	Min.	Typ.	Max.	Unit
<b>Static Electrical Characteristics @ T<sub>J</sub> = 25°C (unless otherwise stated)</b>						
V <sub>(BR)DSS</sub>	Drain- Source Breakdown Voltage	VGS=0V ID=250μA	100	--	--	V
I <sub>DSS</sub>	Zero Gate Voltage Drain current	VDS=100V,VGS=0V	--	--	1	μA
I <sub>GSS</sub>	Gate-Body Leakage Current	VGS=±20V,VDS=0V	--	--	±100	nA
V <sub>GS(TH)</sub>	Gate Threshold Voltage	VDS=VGS,ID=250μA	1	2	2.5	V
R <sub>DS(ON)</sub>	Drain-Source On-State Resistance (Note4)	VGS=10V, ID=30A	--	7.8	9.2	mΩ
		VGS=4.5V, ID=15A	--	10.2	13.5	mΩ
<b>Dynamic Electrical Characteristics @ T<sub>J</sub> = 25°C (unless otherwise stated) (Note5)</b>						
C <sub>iss</sub>	Input Capacitance	VDS=50V, VGS=0V, F=1MHz	--	2140	--	pF
C <sub>oss</sub>	Output Capacitance		--	495	--	pF
C <sub>rss</sub>	Reverse Transfer Capacitance		--	36	--	pF
Q <sub>g</sub>	Total Gate Charge	VDS=50V, ID=30A, VGS=10V	--	38	--	nC
Q <sub>gs</sub>	Gate-Source Charge		--	6.7	--	nC
Q <sub>gd</sub>	Gate-Drain Charge		--	5.6	--	nC
<b>Switching Characteristics (Note5)</b>						
t <sub>d(on)</sub>	Turn-on Delay Time	VDS=50V, ID=25A, RG=6Ω, VGS=10V	--	13	--	nS
t <sub>r</sub>	Turn-on Rise Time		--	39	--	nS
t <sub>d(off)</sub>	Turn-off Delay Time		--	42	--	nS
t <sub>f</sub>	Turn-off Fall Time		--	102	--	nS
<b>Source- Drain Diode Characteristics @ T<sub>J</sub> = 25°C (unless otherwise stated)</b>						
V <sub>SD</sub>	Forward on voltage	IS=20A,VGS=0V	--	--	1.2	V

Note:

- Limited by T<sub>Jmax</sub>, starting T<sub>J</sub> = 25° C, R<sub>G</sub> = 25Ω, V<sub>D</sub> =30V, VGS =10V. Part not recommended for use above this value.
- Repetitive Rating: Pulse width limited by maximum junction temperature.
- Surface Mounted on FR4 Board, t ≤ 10 sec.
- Pulse Test: pulse width ≤ 300 us, duty cycle ≤ 2%.
- Guaranteed by design, not subject to production testing.



## 100V/65A N-Channel Advanced Power MOSFET

### Typical Characteristics

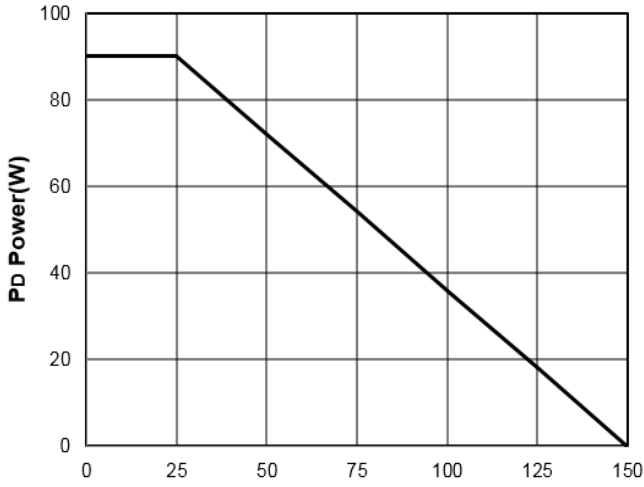

Figure1: T<sub>j</sub> Junction Temperature (°C)

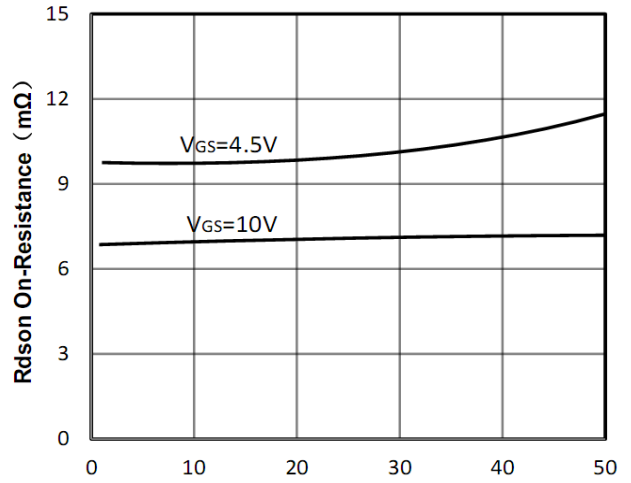

Figure2: I<sub>d</sub> Drain Current (A)

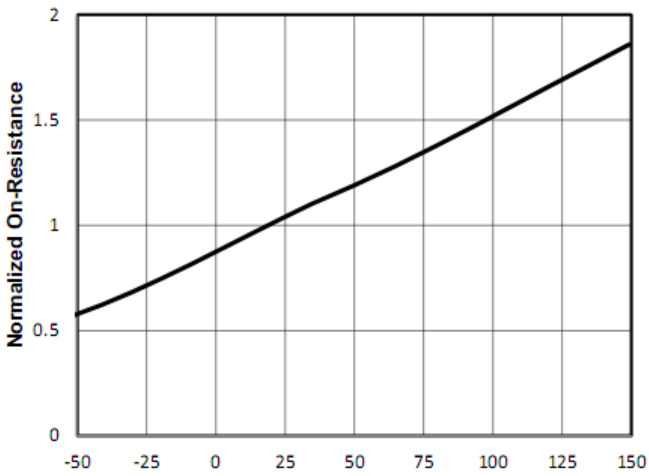

Figure3: T<sub>j</sub> Junction Temperature (°C)

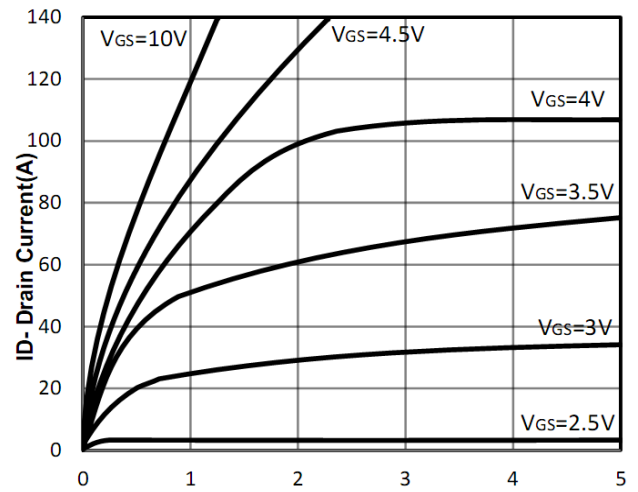

Figure4: V<sub>ds</sub> Drain-Source Voltage (V)

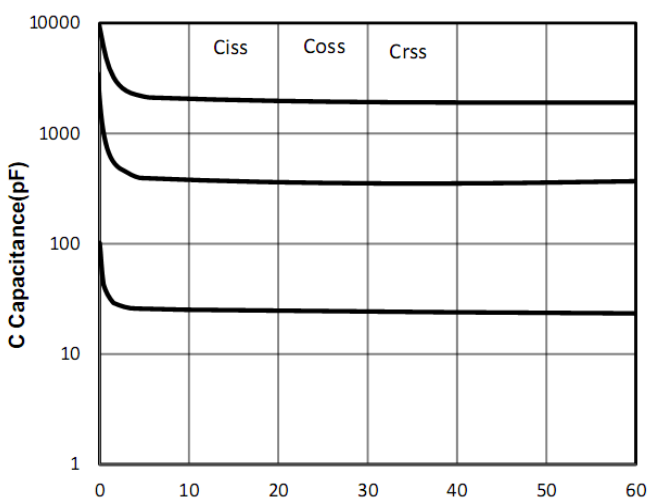

Figure5: V<sub>ds</sub> Drain-Source Voltage (V)

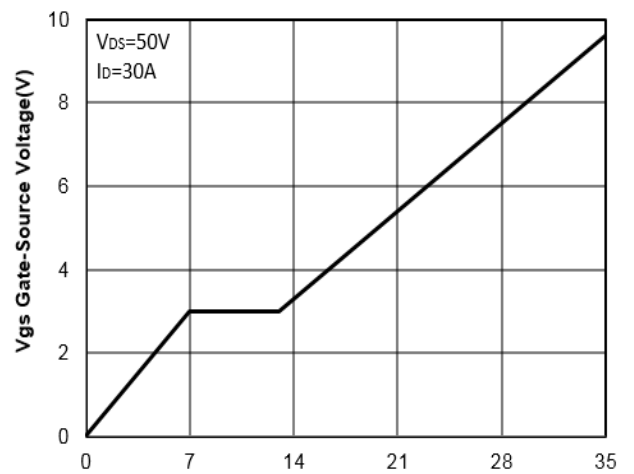

Figure6: Q<sub>g</sub> Gate Charge (nC)



100V/65A N-Channel Advanced Power MOSFET

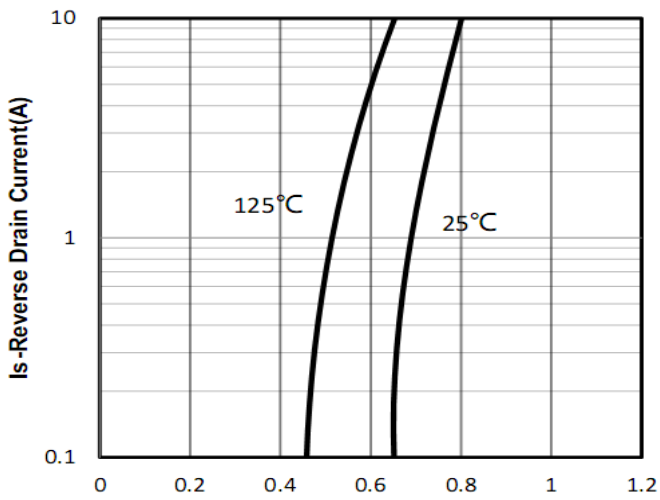

Figure7: Vsd Source-Drain Voltage (V)

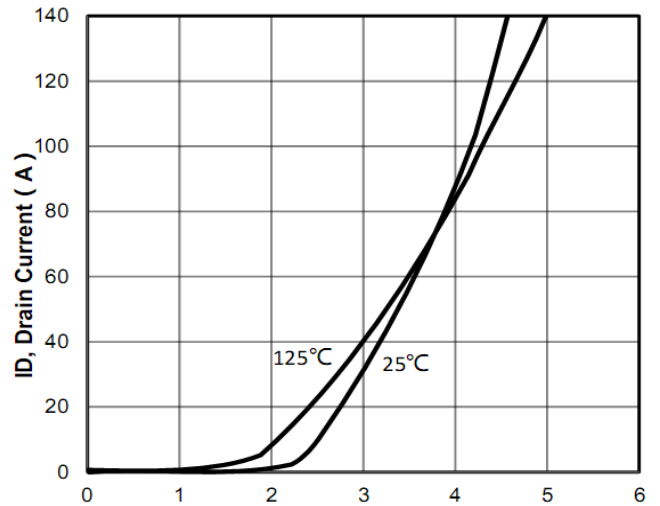

Figure8: Vgs Gate-Source Voltage (V)

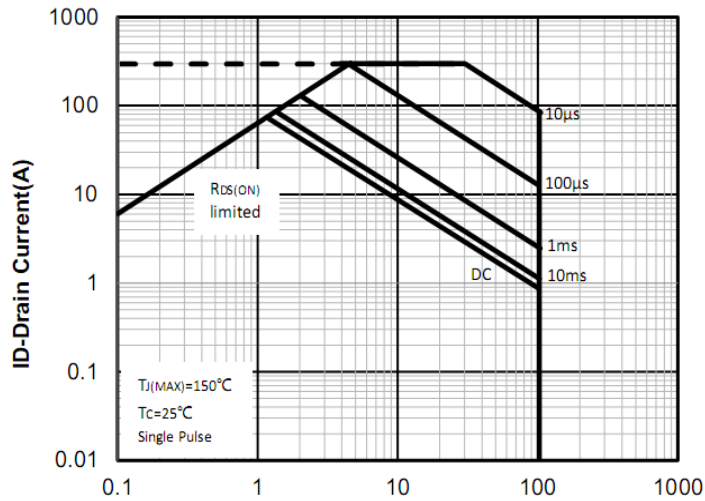

Figure9: Vds Drain-Source Voltage (V)

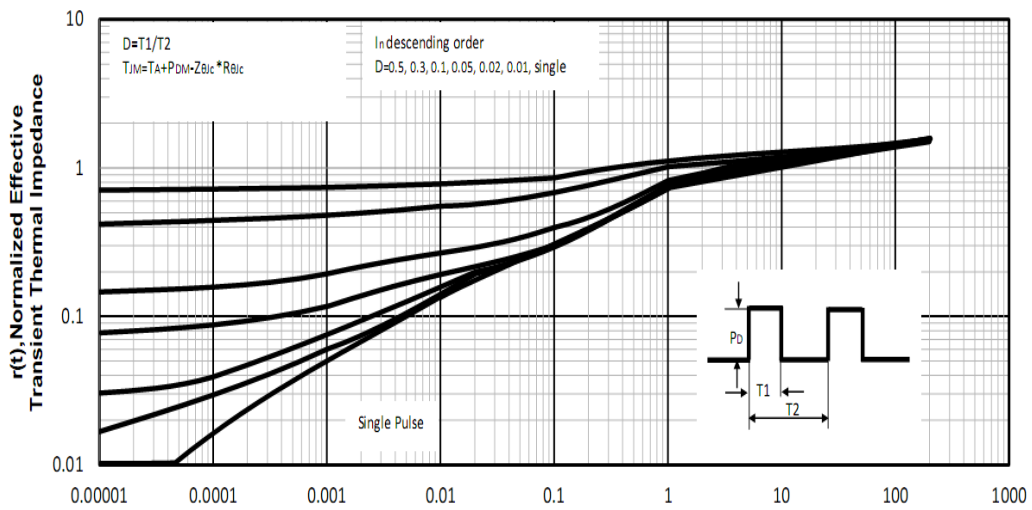

Figure10: Square Wave Pulse Duration (sec)

## 100V/65A N-Channel Advanced Power MOSFET

### Test Circuit and Waveform:

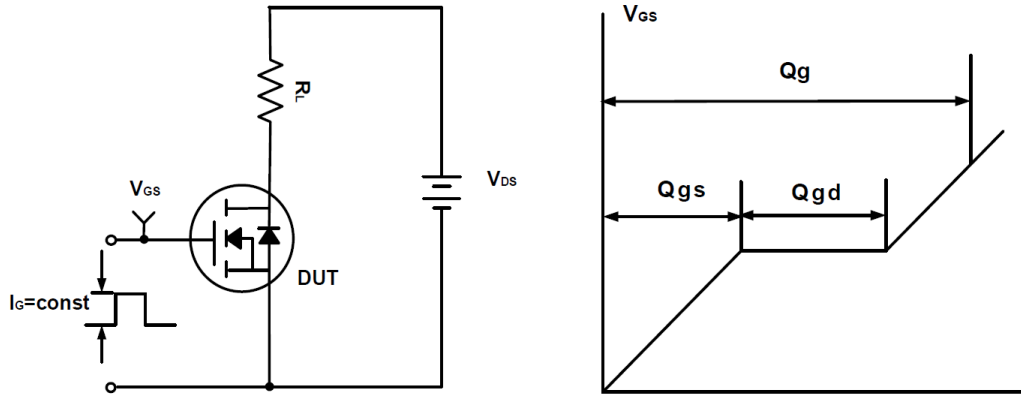

Figure A Gate Charge Test Circuit & Waveforms

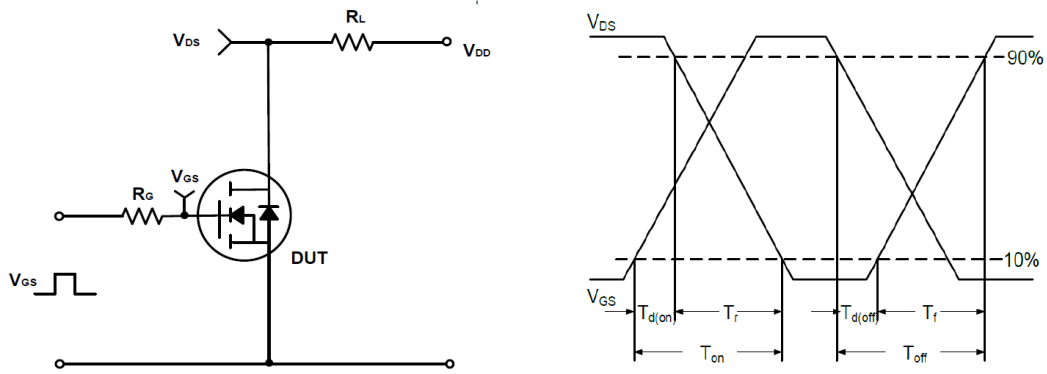

Figure B Switching Test Circuit & Waveforms

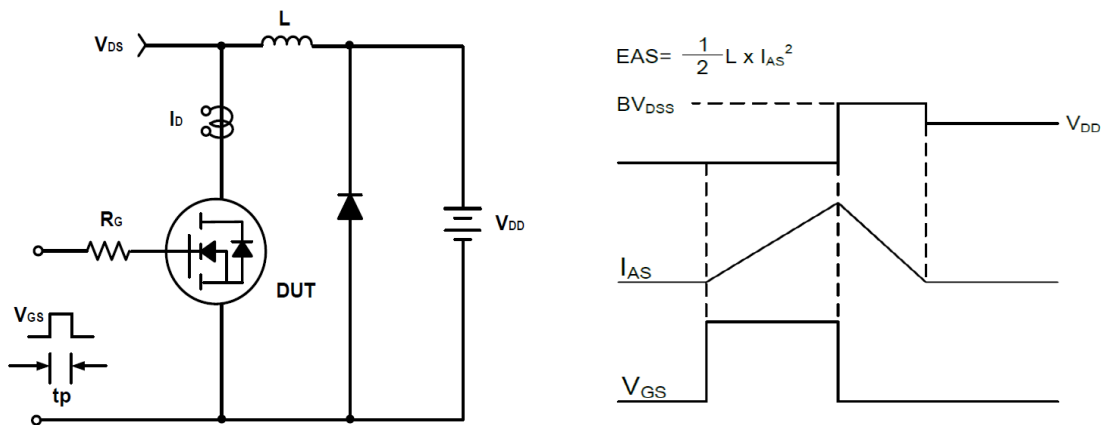
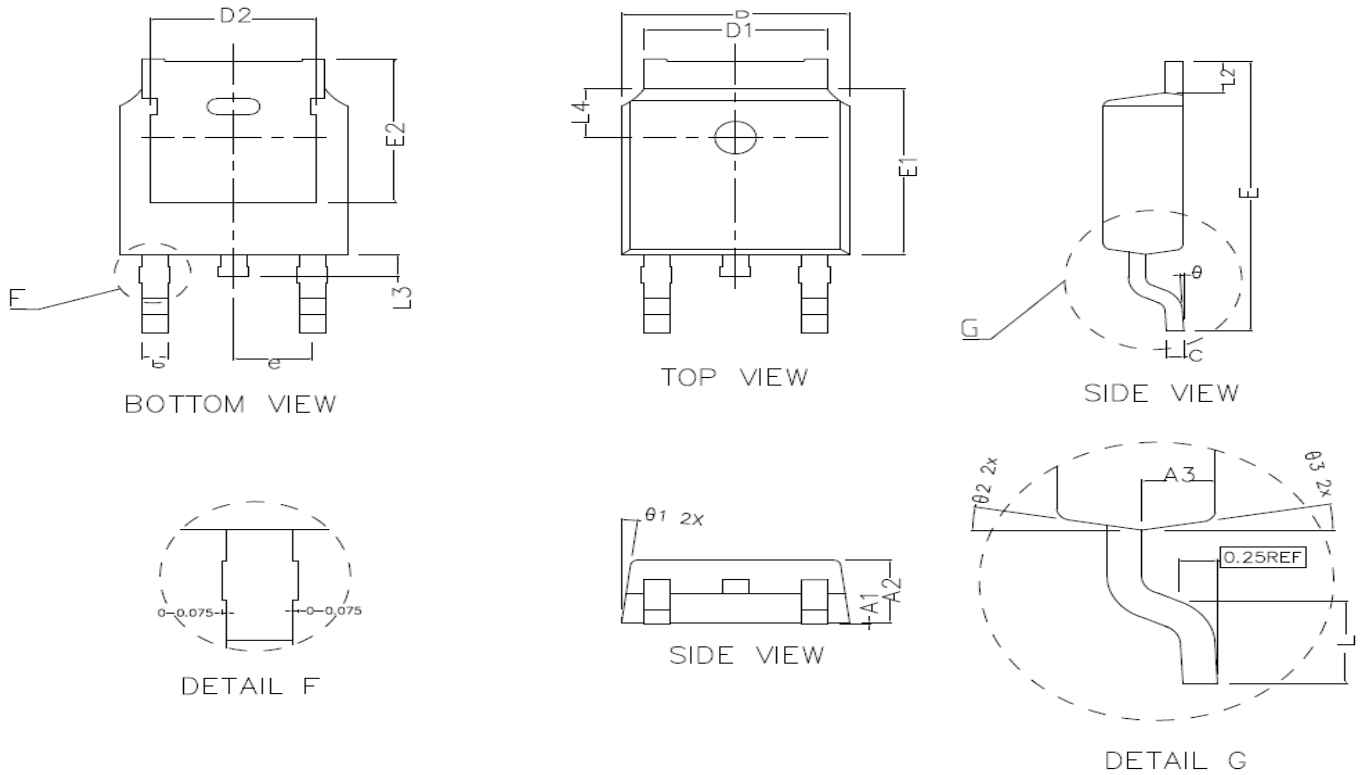

Figure C Unclamped Inductive Switching Circuit & Waveforms



100V/65A N-Channel Advanced Power MOSFET

TO-252 Package Outline Dimensions (Units: mm)



COMMON DIMENSIONS (UNITS OF MEASURE IS mm)			
	MIN	NORMAL	MAX
A1	0.000	0.100	0.150
A2	2.200	2.300	2.400
A3	1.020	1.070	1.120
b	0.710	0.760	0.810
c	0.460	0.508	0.550
D	6.500	6.600	6.700
D1	5.330REF		
D2	4.830REF		
E	9.900	10.100	10.300
E1	6.000	6.100	6.200
E2	5.600REF		
e	2.286TYPE		
L	1.400	1.550	1.700
L2	1.10REF		
L3	0.80REF		
L4	1.80REF		
θ	0~8°		
θ1	7° TYPE		
θ2	10° TYPE		
θ3	10° TYPE		